

Cenník ŠTANDARD šachtové prvky



Centrála spoločnosti

Priemyselná 12, 921 01 Piešťany

Tel.: +421 33 7970 111, Fax: +421 33 7970 119

www.empiria.sk | www.lefresh.sk

EMPIRIA
SRDCE VÁŠHO DOMOVA

■ **Ing. Ľuboš Úradník** - produktový manažér

+421 33 7970 126, uradnik@empiria.sk

Odborné miesto Stupava a Banská Bystrica

Skruže so stupačkami (SP dle ČSN EN 13101)		váha				cena
TBS-Q 1000/1000/90/SP		757				99,53
TBS-Q 1000/500/90/SP		370				57,48
TBS-Q 1000/250/90/SP		185				38,27
Prechodová skruž - konus		váha				
TBR-Q 625/600/90/SPK		432				75,28
Prechodová doska pre tlak 50 a 5 kN		váha				
TZK-Q 625/200/90/T		393				196,04

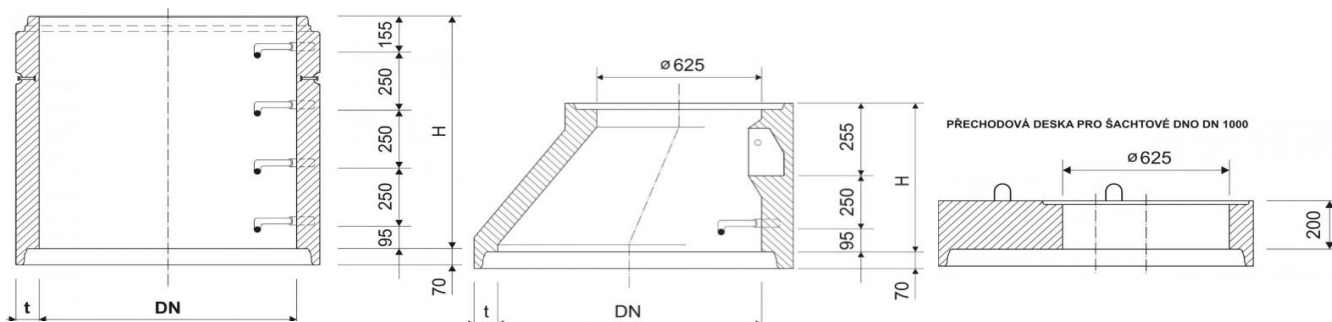

Vyrovňavacie prstence		váha	paleta				cena
TBW-Q 625/40/100	výška 40 mm	22	15				10,12
TBW-Q 625/60/100	výška 60 mm	33	19				10,59
TBW-Q 625/80/100	výška 80 mm	44	14				11,63
TBW-Q 625/100/100	výška 100 mm	54	12				13,12
TBW-Q 625/120/100	výška 120 mm	63	10				15,48
TBW-Q 625/60-110/100	spádový	45	10				18,3

TBW - Q 625 / 60 / 100

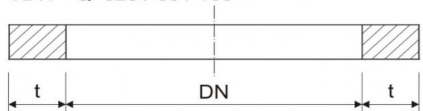

SPÁDOVÝ

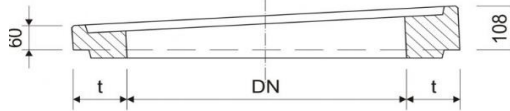

Šachtové dno		váha				cena
TZZ-Q 1000/600	pro potrubí DN 150 - 400	1 350				273,87
TZZ-Q 1000/1000	pro potrubí DN 150 - 600	2 150				334,53
Šachtová vložka		váha				cena
PVC DN 160	hladká	0,30				14,99
PVC DN 200	hladká	0,60				17,47
PVC DN 250	hladká	0,80				20,8
PVC DN 315	hladká	1,00				26,62
PVC DN 400	hladká	1,50				38,27

Výpočet dopravných nákladov pre doručenie na stavbu - /počet km x 1,3€

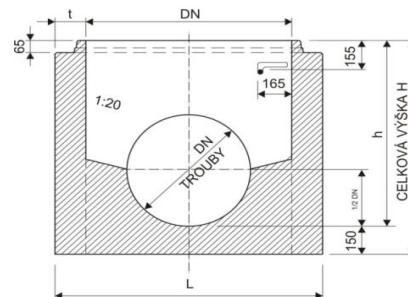

Uličné vpuste	Popis	váha	paleta	cena
TBV-Q 390/60/10a	vyrov. prstenec pro rám 500x500	27	30	10,05
TBV-Q 450/195/5c	skruž horní	40	24	11,72
TBV-Q 450/295/5b	skruž horní	58	16	15,74
TBV-Q 450/555/5d	skruž horní	111	8	26,5
TBV-Q 450/195/6b	skruž středová	40	28	11,72
TBV-Q 450/295/6a	skruž středová	57	16	15,74
TBV-Q 450/555/6d	skruž středová	11	8	26,5
TBV-Q 450/350/3a PVC	skruž s otvorem PVC DN 150	80	16	25,41
TBV-Q 450/450/3d PVC	skruž s otvorem PVC DN 200	90	12	29,1
TBV-Q 450/300/2a	kalová prohlubeň	72	20	17,06
TBV-Q 450/330/1a PVC	dno s výtokem PVC DN 150	96	12	27,92
TBV-Q 450/380/1d PVC	dno s výtokem PVC DN 200	108	8	30,33
TBV-Q 450/940/2k V	vysoké kalové dno s horním výtokem	215	4	64,48
TBV-Q 450/940/2k N	vysoké kalové dno se spodním výtokem	215	4	64,48

VYROVNÁVACÍ PRSTENCE

TBV - Q 390 / 60 / 10a

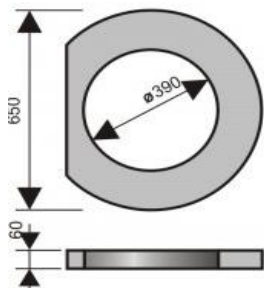

SKRUŽE HORNÍ

TBV - Q 450 / 195 / 5



TBV - Q 450 / 295 / 5

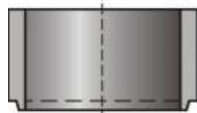

SKRUŽE STŘEDOVÉ

TBV - Q 450 / 195 / 6b



TBV - Q 450 / 295 / 6a



SKRUŽ S OTVOREM pro PVC DN 150
TBV - Q 450 / 350 / 3a PVC

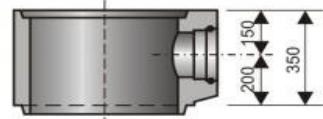

TBV - Q 450 / 450 / 3d PVC

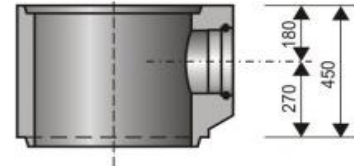

DNO S KALOVOU PROHLUBNI

TBV - Q 450 / 290 / 2a

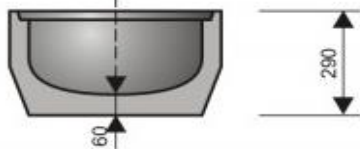

TBV - Q 450 / 570 / 5

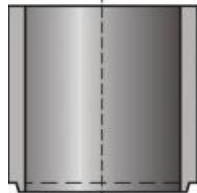

TBV - Q 450 / 570 / 6d

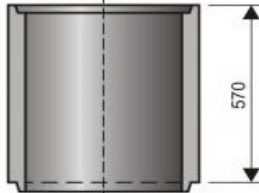

DNO S VÝTOKEM pro PVC UN DN 150

TBV - Q 450 / 330 / 1a PVC UN

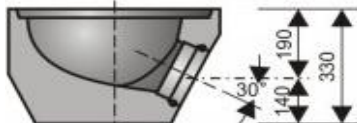

DNO S VÝTOKEM PVC DN 200

TBV - Q 450 / 380 / 1d PVC

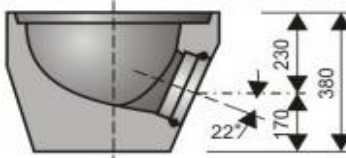

KALOVÉ DNO S VÝTOKEM

TBV - Q 450 / 940 / 2KV

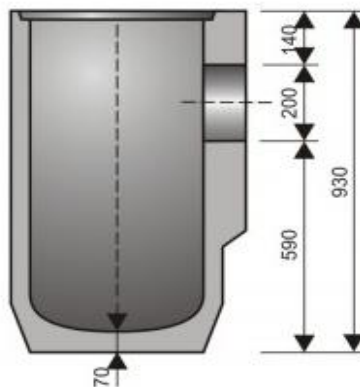

KALOVÉ DNO S VÝTOKEM

TBV - Q 450 / 940 / 2KN

